

Lucalox™ XO

High Pressure Sodium Lamps with improved reliability

Lucalox™ XO Tubular Clear

50W, 70W, 100W, 150W, 250W, 400W & 600W

Lucalox™ XO Elliptical Diffuse

50W, 70W, 100W, 150W, 250W & 400W

Product information

GE Lucalox™ XO High Pressure Sodium lamps offer outstanding luminous efficacy, lumen maintenance and long life, thus reducing energy and maintenance costs.

Features

Lucalox™ XO lamps are of very robust and reliable construction, designed to meet the most demanding requirements. There are fewer parts and only 5 critical welds.

Simplicity and robustness deliver higher reliability. In addition, they are compatible with both magnetic and GE approved electronic ballasts.

Superb performance and longer life

- GE's sodium resistant ceramic allows slow voltage rise to give a rated average life up to 35,000 hours
- Rugged monolithic arc tube with GE Reliable Starting Technology for higher reliability

High xenon-fill gas delivers:

- High luminous efficiency, up to 146 lm/W
- Extra light, up to 20% more lumens than standard

High Pressure Sodium lamps – without increased energy consumption

- More resistant to mains voltage fluctuations
- Zirconium gettering system for improved lumen maintenance



Applications



Road and Tunnel



Industrial



Specialty



Street and Pedestrian



Car Park



Basic data

Lucalox™ XO Tubular Clear

Product Code	93373	93375	93376	93377	93378	93269	93270
Product Description	LU50/85/ XO/T/27	LU70/90/ XO/T/27	LU100/100/ XO/T/40	LU150/100/ XO/T/40	LU250/ XO/T/40	LU400/ XO/T/40	LU600/ XO/T/40
Nominal Wattage [W]	50	70	100	150	250	400	600
Rated Wattage [W]	54.2	73	102	153	260	408	607
Weighted Energy Consumption [kWh/1000 hrs]	59.63	80.43	111.89	168.30	285.73	448.34	667.21
Volts [V]	85	90	100	100	100	100	115
Cap	E27	E27	E40	E40	E40	E40	E40
Nominal Lumen [lm]	4400	6600	10700	17500	33200	56500	88500
Rated Lumen [lm]	4400	6620	10720	17600	33210	56510	88750
Rated Lamp Efficacy [lm/W]	81	91	105	115	128	139	146
Energy Efficiency Class [EEC]	A	A+	A+	A+	A+	A++	A++
Mercury Content [mg]	8.3	10.0	13.3	13.3	23.2	19.2	21.1
Average Rated Life [h]	35000	40000	40000	45000	45000	45000	32000
Colour Rendering Index [Ra]	25	25	25	25	25	25	25
Ambient Temperature [°C]	25	25	25	25	25	25	25
Bulb	Soft	Soft	Hard	Hard	Hard	Hard	Hard
Mass Weight [g]	65	65	140	150	155	175	180
Operating Position	Universal	Universal	Universal	Universal	Universal	Universal	Universal
Minimum Starting Temp. [°C]	-40	-40	-40	-40	-40	-40	-40

Lucalox™ XO Elliptical Diffuse

Product Code	45696	45697	93379	93380	93381	93296
Product Description	LU50/85/ XO/D/27	LU70/90/ XO/D/27	LU100/100/ XO/D/40	LU150/100/ XO/D/40	LU250/ XO/D/40	LU400/ XO/D/40
Nominal Wattage [W]	50	70	100	150	250	400
Rated Wattage [W]	53	76	102	155	260	403
Weighted Energy Consumption [kWh/1000 hrs]	58.31	83.83	112.19	170.14	285.67	443.02
Volts [V]	85	90	100	100	100	105
Cap	E27	E27	E40	E40	E40	E40
Nominal Lumen [lm]	3600	6000	10200	16900	31200	54000
Rated Lumen [lm]	4060	6260	10230	17150	31460	54810
Rated Lamp Efficacy [lm/W]	77	86	100	111	121	136
Energy Efficiency Class [EEC]	A	A	A+	A+	A+	A+
Mercury Content [mg]	8.3	10.0	13.3	13.3	23.2	19.2
Average Rated Life [h]	35000	40000	40000	45000	45000	45000
Colour Rendering Index [Ra]	25	25	25	25	25	25
Ambient Temperature [°C]	25	25	25	25	25	25
Bulb	Soft	Soft	Hard	Hard	Hard	Hard
Mass Weight [g]	65	67	140	175	195	250
Operating Position	Universal	Universal	Universal	Universal	Universal	Universal
Minimum Starting Temp. [°C]	-40	-40	-40	-40	-40	-40

Dimensions

Figure 1.

Figure 2.

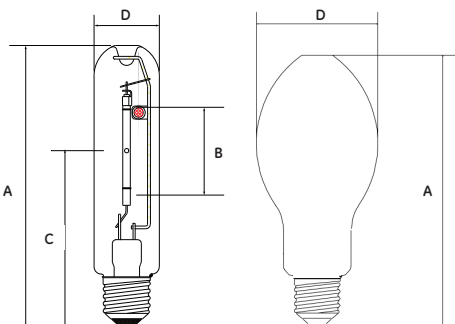

Lucalox™ XO - Tubular Clear – Figure 1.

Product Code	93373	93375	93376	93377	93378	93269	93270
Wattage [W]	50	70	100	150	250	400	600
A Length [mm]	156	156	211	211	260	292	292
B Arc Gap [mm]	30	38	44	58	67	87	117
C LCL [mm]	102	102	132	132	158	175	170
D Diameter [mm]	39	39	48	48	48	48	48

Lucalox™ XO - Elliptical Diffuse – Figure 2.

Product Code	45696	45697	93379	93380	93381	93296
Wattage [W]	50	70	100	150	250	400
A Length [mm]	156	156	186	227	227	292
D Diameter [mm]	72	72	76	91	91	122

Photometric data

Wattage	CCT [K]	Properties DIN 5035 Class
Lucalox™ XO Clear Tubular – Figure 1.		
50	2100	4
70	2100	4
100	2100	4
150	2100	4
250	2100	4
400	2100	4
600	2100	4
Lucalox™ XO Diffuse Elliptical – Figure 2.		
50	2100	4
70	2100	4
100	2100	4
150	2100	4
250	2100	4
400	2100	4

Spectral power distribution

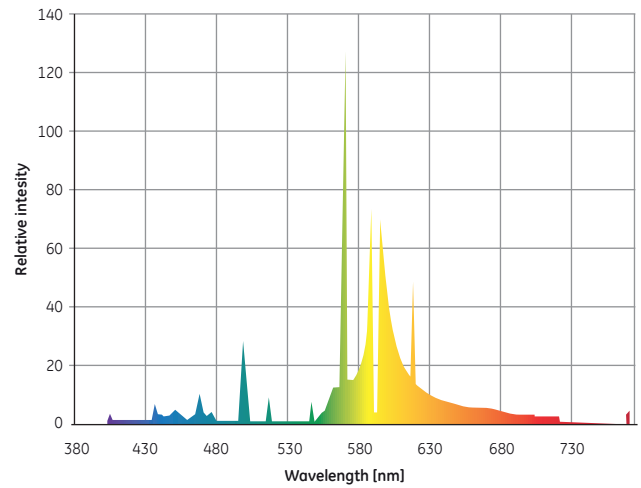

Survival rate and lumen maintenance

Average lamp life & lumen maintenance is based on laboratory tests of a large number of representative lamps under controlled conditions, including operation at 11 hours per start on ballasts having specified electrical characteristics. The following conditions can reduce average lamp life and lumen maintenance:

- frequent on/off switching
- high line voltage
- excessive vibration
- high ambient temperature within the fixture
- ballast and ignitor characteristics.

Survival rate of XO 100W lamp

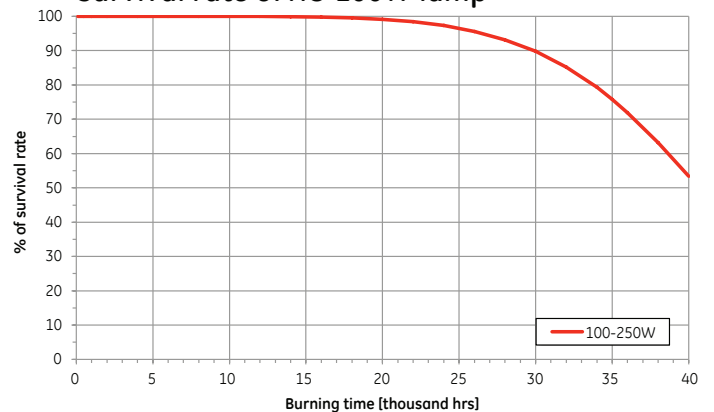

Survival rate of XO 50-70W lamps

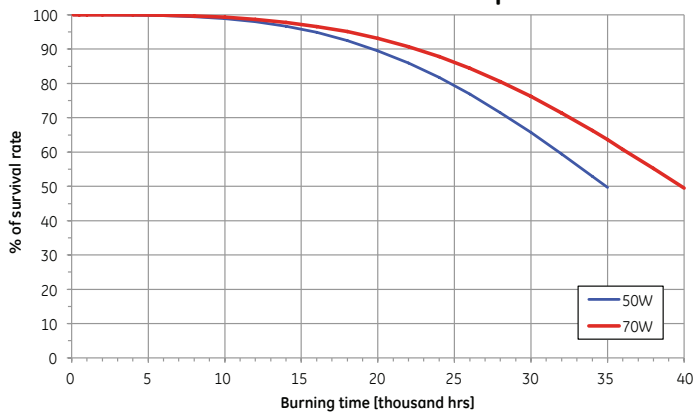

Survival rate of XO 600W lamp

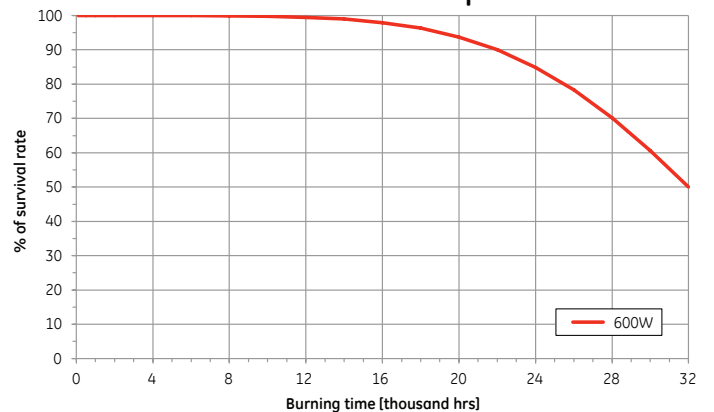

Survival rate of XO 150-400W lamps

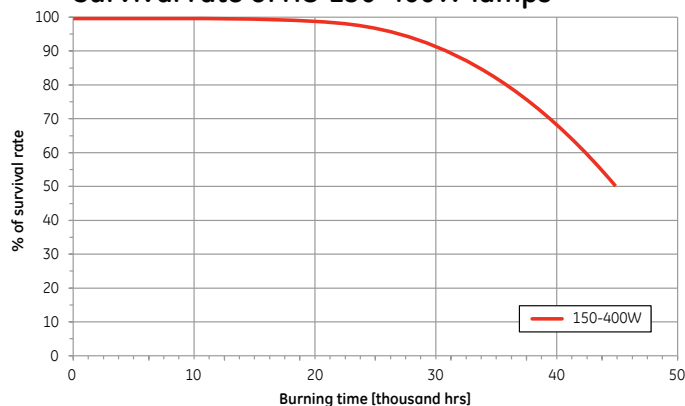

Average rated life

The survival of individual lamps or particular groups of lamps depends on the above described system conditions (see Lamp Survival graph). For cost-of-light calculations involving these lamps, the following estimated operating time is suggested: 50% survival at 35,000 hours for 50W, 40,000 hours for 70W-100W, 45,000 hours for 150-400W and 32,000 hours for 600W.

Wattage	50	70	100	150	250	400	600
B3 [h]	13,500	15,500	24,400	24,300	24,300	24,300	17,200
B5 [h]	15,900	18,100	26,600	27,000	27,000	27,000	19,100
B10 [h]	19,700	22,500	29,900	31,000	31,000	31,000	22,000

Lumen maintenance

Under the same controlled conditions, Initial Reference lumens refer to the lamp lumen output after 100-hours burning. Due to variations in systems and service conditions (in particular the burning cycle), actual lamp performance can vary from the reference lumen ratings. The lumen maintenance (light output during life) of individual lamps or particular groups of lamps can be seen on the Lumen Maintenance chart.

Lumen maintenance of XO 50-70W

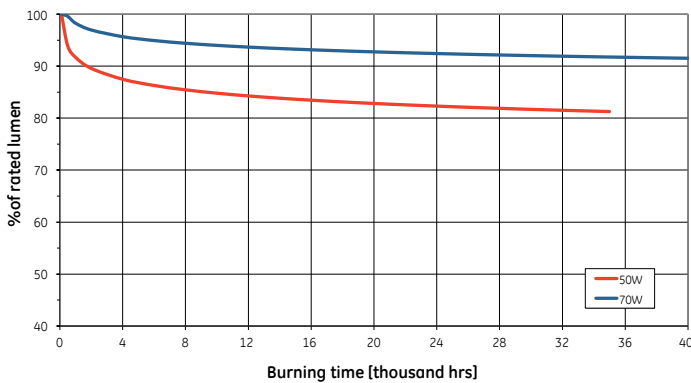

Lumen maintenance of XO 100-150W

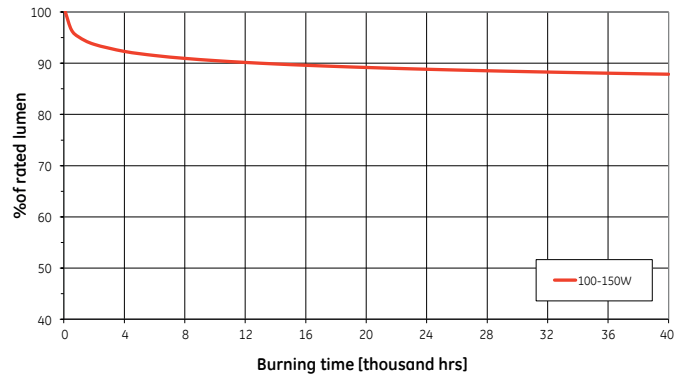

Lumen maintenance of XO 250-400W lamps

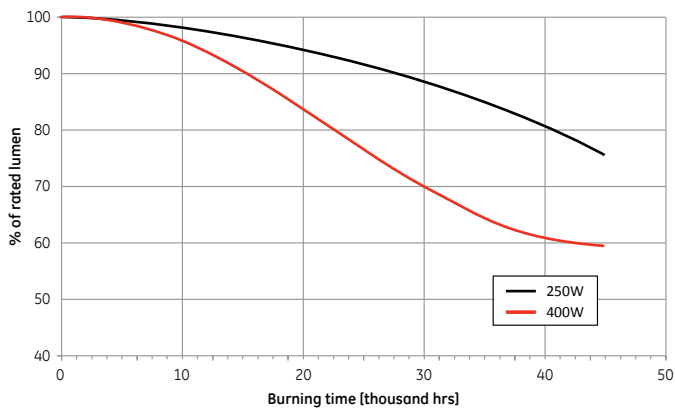

Lumen maintenance of XO 600W

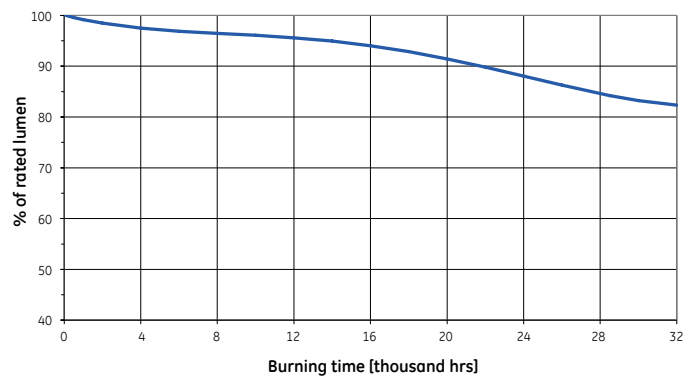

Electrical data

Data is based on a nominal lamp operating from a nominal choke (reactor) ballast with power factor correction. Supply power is based on a typical commercially available ballast.

Wattage	Volts ±15 [V]	Current [A]	Power [W]	Current Crest Factor
Lucalox™ XO – Clear Tubular				
50	85	0.76	50	1.80
70	90	0.98	70	1.80
100	100	1.2	100	1.80
150	100	1.8	150	1.80
250	100	2.9	250	1.80
400	100	4.5	400	1.80
600	112	6	600	1.80
Lucalox™ XO – Diffuse Elliptical				
50	85	0.76	50	1.80
70	90	0.98	70	1.80
100	100	1.2	100	1.80
150	100	1.8	150	1.80
250	100	2.9	250	1.80
400	100	4.4	400	1.80

Run-up characteristics

The graph shows typical run-up characteristics for a 150W Lucalox™ XO lamp. The time needed for the light output to reach 90% of the final value is determined by the supply voltage and ballast design. Typical values are:

Watts	50	70	100	150	250	400	600
Run-UP (Mins)	3	5	3.5	3.5	3	5	4

Typical run-up characteristics

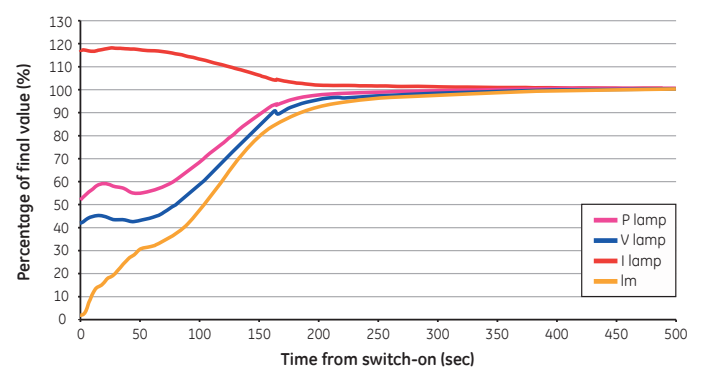

Hot restrike time

All ratings restrike within 4 minutes. This occurs when the lamp has cooled to a temperature at which the starting aid can re-establish the arc. The new solid state starting aid is integrally bonded to the arc tube for shorter restrike time, and improved reliability – no moving parts or welds.

Supply voltage

Lamps are suitable for supplies in the range 220V to 250V 50/60Hz for appropriately rated series choke (reactor) ballasts. Supplies outside this range require a transformer (conventional, high reactance or CWA) to ensure correct lamp operation. Lamps start and operate at 10% below the rated supply voltage when the correct control gear is used. In order to maximise lamp survival, lumen maintenance and colour uniformity, the supply voltage and ballast design voltage should be within $\pm 3\%$. Supply variations of $\pm 5\%$ are permissible for short periods only. This may be achieved by measuring mean supply voltage at the installation and selecting ballasts with appropriate settings.

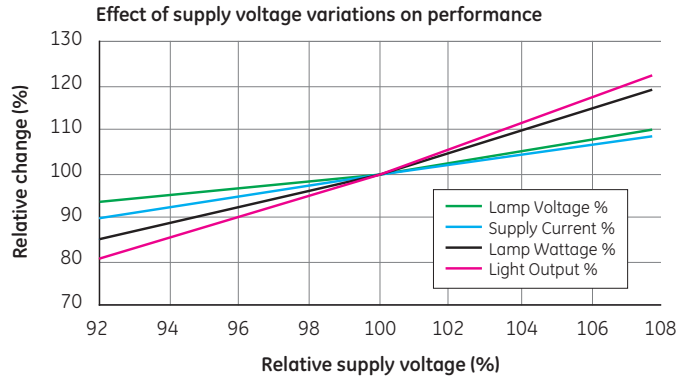

Ballasts

It is essential to use a ballast appropriate to the supply voltage at the luminaire. Typical wiring diagrams for control circuits incorporating “Superimposed” or “Impulser” ignitor and choke (reactor) ballast are shown. Refer to actual choke and ignitor manufacturers’ data for terminal identification and wiring information.

Typical impulser ignitor circuit

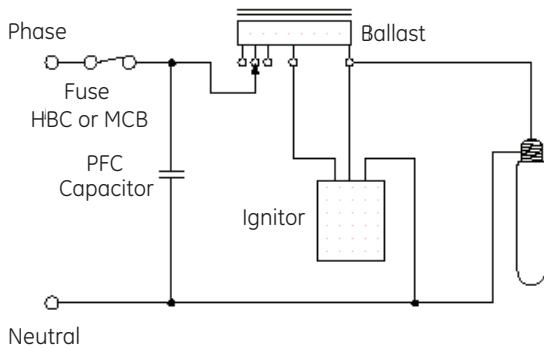

Typical superimposed ignitor circuit

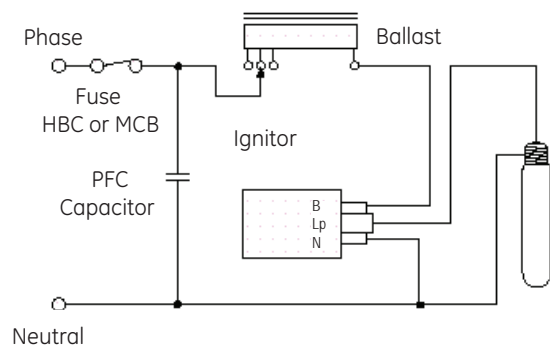

Guidance for luminaire manufacturers

Lamp operating temperature limits

	50-70W	100-600W
Max. Cap Temperature	210°C	250°C
Max. Bulb Temperature	310°C	400°C

Luminaire voltage rise

To maximise lamp life it is essential that luminaires are designed so that when lamps are enclosed lamp voltage rise does not exceed the following values:

Watts	50	70	100	150	250	400	600
Clear Tubular							
Voltage Rise (V)	5	5	7	7	10	12	12
Diffuse Elliptical							
Voltage Rise (V)	5	5	5	5	10	7	-

Ballasts

To achieve correct lamp starting, performance and life, it is important that the lamp and ballast are compatible and suitably rated for the supply voltage at the luminaire. The Lucalox™ XO range is compatible with IEC60662 (High Pressure Sodium Lamps) and IEC62035 (HID Lamp Safety). Ballasts used to operate these lamps should comply with ballast standards IEC60922 & IEC60923 and incorporate adequate overload protective measures to ensure that safety is maintained under abnormal lamp end-of-life rectification conditions as prescribed by IEC60662, IEC62035 and draft changes to luminaire standard EN60598-1. Ballast thermal protection is one method of providing adequate protection.

Ballast voltage adjustment

Series choke (reactor) ballasts incorporating additional tapings at $\pm 10V$ of the rated supply voltage are recommended. Alternatively, a single additional tapping 10V above the rated supply voltage will ensure lamps are not overloaded due to excessive supply voltage.

Ignitors

Ignitors should comply with specifications IEC60926 and IEC60927 and have starting pulse characteristics as shown in the table on the right.

Timed ignitors

Use of a “timed” or “cut-out” ignitor is not a specific requirement, but it is a good optional safety feature for the installation. The timed period must be adequate to allow lamps to cool and restart when the supply is interrupted briefly (see “Hot Restrike Time”). A period of 10 minutes continuous or intermittent operation is recommended before the ignitor is automatically switched off. Commercially available 10/11 minute timed ignitors are suitable.

Watts	Min. Pulse Voltage [kV] ¹	Max. Pulse Voltage [kV] ²	Min. Pulse Width [μ s] ³	Min. Pulse Repetition Rate ⁴
50	1.8	2.3	1.95	1/½ cycle
70	1.8	2.3	1.95	1/½ cycle
100	2.8	5.0	1.95	1/cycle
150	2.8	5.0	1.95	1/cycle
250	3.3	5.0	1.95	1/cycle
400	3.3	5.0	1.95	1/cycle
600	3.6	5.0	1.95	1/cycle

1. When Loaded with 100 pF min.
2. When Loaded with 20 pF max.

3. At 90 % peak voltage
4. Pulse Phase Angle: 60-90°el and/or 240-270° el.

Cable between ignitor and lamp

Cables connected between the lamp and a superimposed ignitor “Lp” terminal, or the ballast when using an impulser ignitor, must be rated at a minimum 50/60Hz voltage of 1000V. Mineral-insulated cables are not suitable for connecting the lamp to the control gear. To achieve good starting superimposed ignitors must be adjacent to the luminaire. Cable capacitance of wiring between the ignitor “Lp” terminal and the lamp should not exceed 100pF (<1 metre length) when measured to adjacent earthed metal and/or other cables, unless otherwise stated by the ignitor manufacturer. When using impulser type ignitors, longer cable lengths between ballast and lamp are normally permissible. Limits for particular ignitors are available directly from the ignitor manufacturer.

PFC capacitors for choke (reactor) circuits

Power Factor Correction is advisable in order to minimise supply current and electricity costs. For 220-250V supplies, 250V \pm 10% rated capacitors are recommended as follows:

Watts	50	70	100	150	250	400	600
PFC Capacitor (μ F)	10	11	13	22	33	50	60